

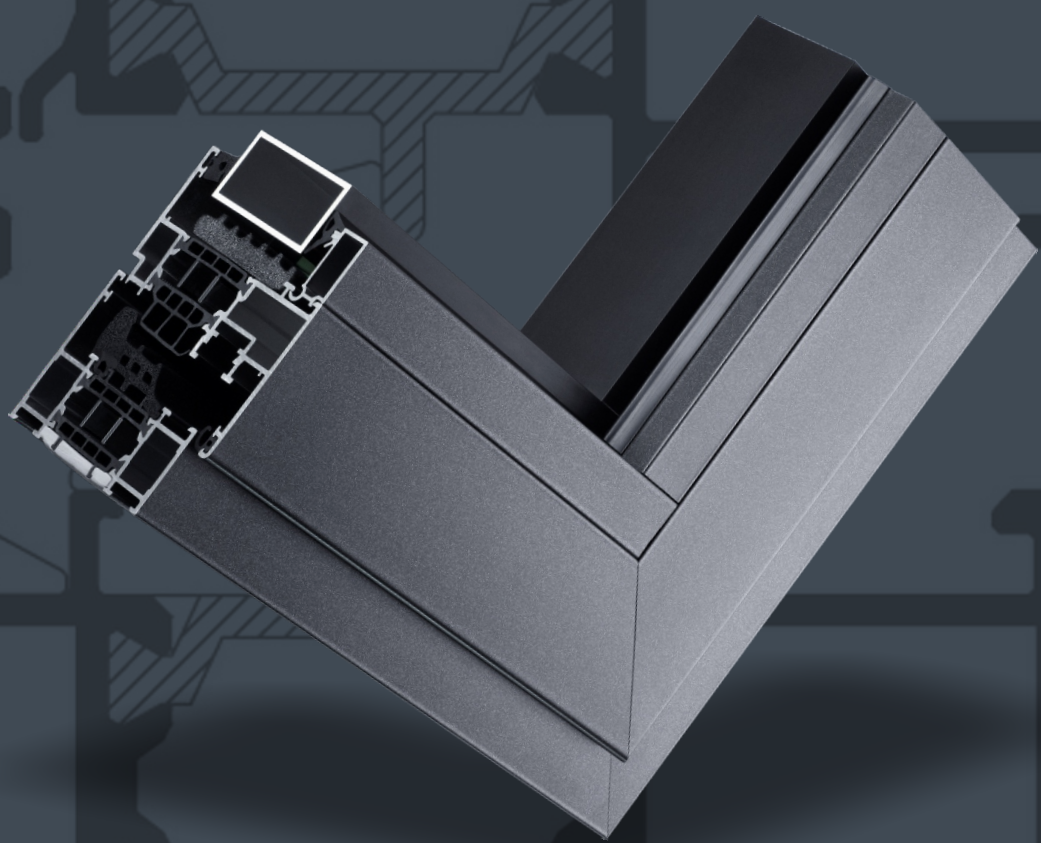

INDICE DE PERFILES

# RPT



**ALUMAK**  
SOLUCION EN ALUMINIO



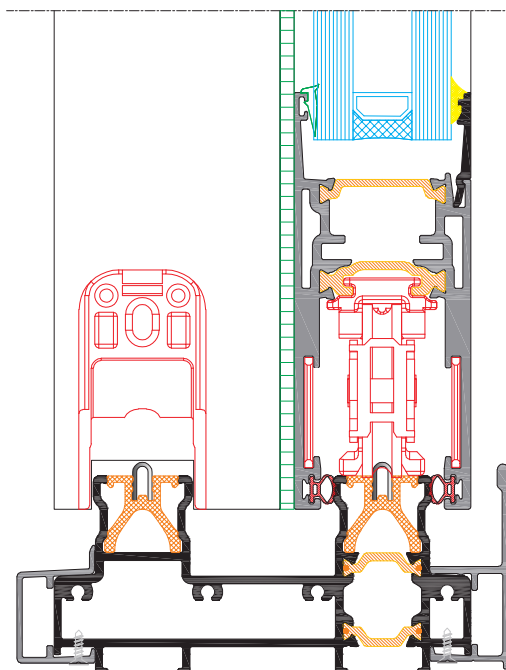

## TIPOLOGÍAS

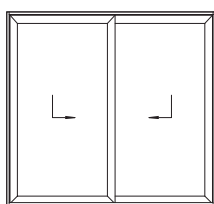

Balcón 2 hojas alzantes

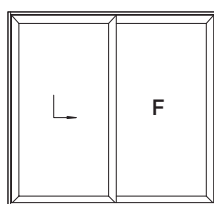

Balcón 1 hoja alzante  
+ 1 hoja fija

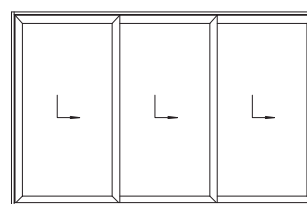

Balcón 3 hojas alzantes  
en 3 guías

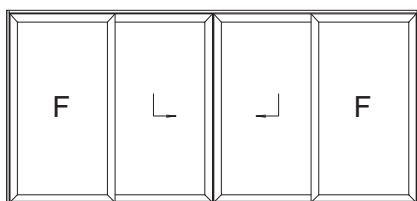



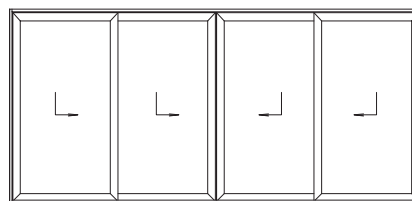







Balcón 2 hojas centrales alzantes  
+ 2 hojas laterales fijas en 2 guías.

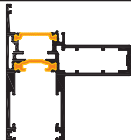









Balcón 4 hojas alzantes  
con encuentro central

## HERREMENTAL NECESARIO

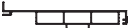
Código	Descripción
91005	Prensa base para sistema porta matrices Hydro Pack
91090	Matriz N°1 HA110 Alzante RPT - HydroPack
91091	Matriz N°2 HA110 Alzante RPT - HydroPack
91092	Matriz N°3 HA110 Alzante RPT - HydroPack

Código	Diseño	Descripción	kg/m
ADR 88010		Encuentro de 4 hojas	0,612
ADR 88009		Hoja Ref. ext. p/cont. Jxx = xx,x cm4	3,089
ADR 88008		Hoja Ref. int. p/cont. Jxx = xx,x cm4	3,088
ADR 88007		Hoja con Refuerzo Jxx = xx,x cm4	3,321
ADR 88006		Hoja Simple p/cont. Jxx = xx,x cm4	2,359
ADR 88005		Hoja Simple Jxx = xx,x cm4	2,496
ADR 88004		Jamba de marco de 3 guías	2,593
ADR 88003		Umbral / Dintel de 3 guías	3,488
ADR 88002		Jamba de marco de 2 guías	1,850
ADR 88001		Umbral / Dintel de 2 guías	2,312
ADR 3575		Tapajuntas HA110 RPT	0,167

<b>Código</b>	<b>Diseño</b>	<b>Descripción</b>	<b>kg/m</b>
ADR 3723		Tapa Hoja - Cruce HA110 RPT	0,388
ADR 3722		Contravidrio HA110 RPT	0,176
ADR 3714		Colector Condensado HA110 RPT	0,423
ADR 3713		Cubre Umbral HA110 RPT	0,281
ADR 2614		Tapajuntas Curvo 34 mm atornillado	0,222
ADR 2561		Premarco Doppia de 150 mm	1,397
ADR 2548		Premarco Doppia de 120 mm	1,261
ADR 2462		Tapa Premarco Doppia	0,191
ADR 1910		Tapa Premarco R750	0,156

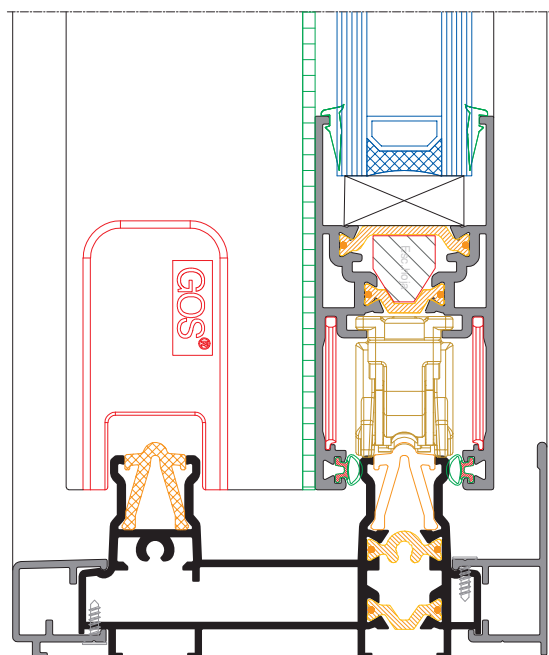

## TIPOLOGÍAS

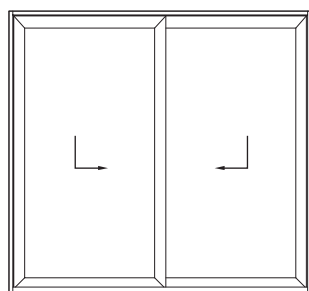



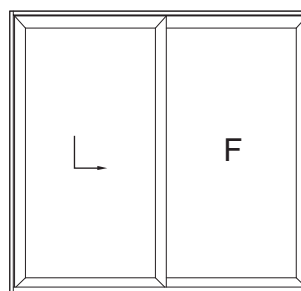





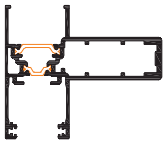

Balcón 2 hojas alzantes

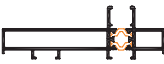
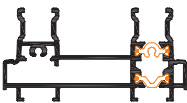



Balcón 1 hoja alzante  
y 1 hoja Fija

## HERREMENTAL NECESARIO

Código	Descripción
91005	Prensa base para sistema porta matrices Hydro Pack
91050	Matriz N°1 HA62 Alzante RPT - HydroPack
91051	Matriz N°2 HA62 Alzante RPT - HydroPack

Código	Diseño	Descripción	kg/m
ADR 87404		Hoja Reforzada Jxx = 65.8 cm <sup>4</sup>	2,200
ADR 87403		Hoja Jxx = 10,1 cm <sup>4</sup>	1,396
ADR 87402		Jamba de marco	1,458
ADR 87401		Umbral/dintel de marco	1,650
ADR 3575		Tapajuntas HA62 Alzante RPT	0,167
ADR 3574		Tapa de hoja	0,417
ADR 3569		Colector de Condensado	0,214
ADR 3568		Cubre Umbral	0,181
ADR 2614		Tapajuntas Curvo 34 mm atornillado	0,222
ADR 2462		Tapa Premarco Doppia	0,191
ADR 1910		Tapa Premarco R750	0,156

<b>Código</b>	<b>Diseño</b>	<b>Descripción</b>	<b>kg/m</b>
<b>ADR 1909</b>		Premarco R750	0,645
<b>ADR 375</b>		Premarco R700	0,605
<b>ADR 230</b>		Premarco	0,463

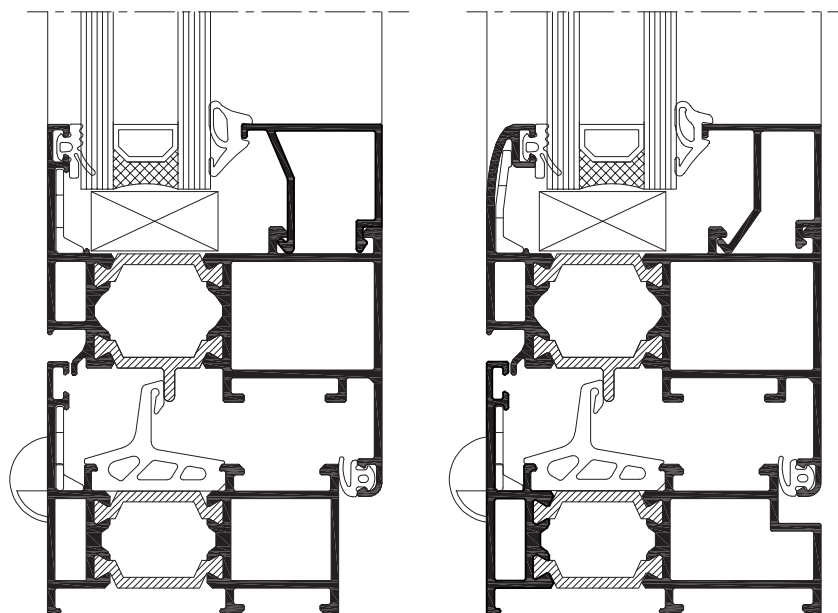

## TIPOLOGÍAS

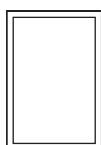

Paño Fijo

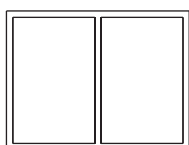

Paño Fijo  
Compuesto

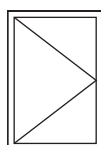

Ventana 1 hoja  
Batiente  
Oscilobatiente

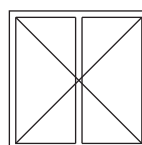

Ventana 2 hojas  
Batiente  
Oscilobatiente

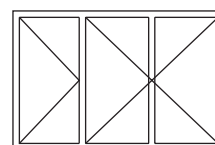

Ventana 3 hojas  
Batiente  
Oscilobatiente

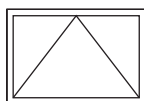

Banderola

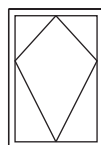

Desplazable

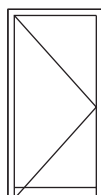

Puerta 1 hoja  
Apertura  
Interior y Exterior

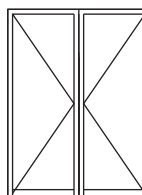

Puerta 2 hojas  
Apertura  
Interior y Exterior

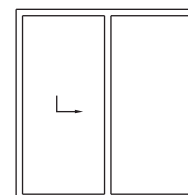





Puerta Oscilo-Paralela  
y Paño Fijo



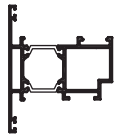

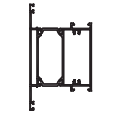
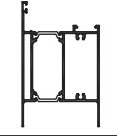
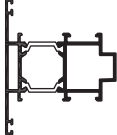
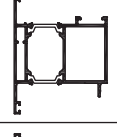
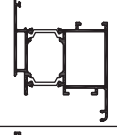
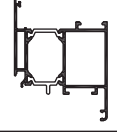
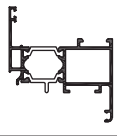
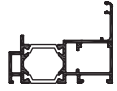
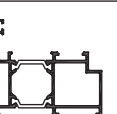
## HERREMENTAL NECESARIO

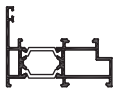

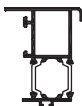
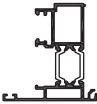
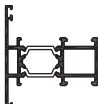
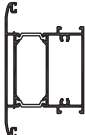
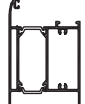
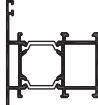
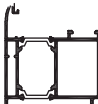
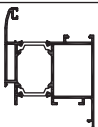

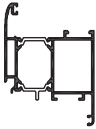
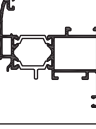
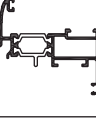
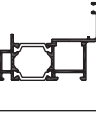
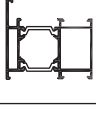
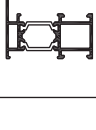
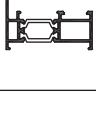





Código	Descripción
91005	Prensa base para sistema porta matrices Hydro Pack
91061	Matriz N2 HA62 RPT - Batiente - Hydro Pack











Código	Diseño	Descripción	kg/m
ADR 86480		Hoja Desplazable	1,361
ADR 86440		Acople Módulo 62 mm	0,587
ADR 86424		Travesaño Puerta Recto	1,902
ADR 86423		Zócalo Puerta Recto	1,863
ADR 86420		Travesaño Coplanar	1,350
ADR 86415		Hoja Puerta Aper Exterior Recta.	1,607
ADR 86414		Hoja Puerta Recta	1,487
ADR 86412		Hoja Balcón Recta	1,477
ADR 86411		Hoja Ventana Recta	1,209
ADR 86408		Marco Ventana Desplazable Coplanar	1,125
ADR 86403		Marco Puerta Coplanar	1,245

<b>Código</b>	<b>Diseño</b>	<b>Descripción</b>	<b>kg/m</b>
ADR 86402		Marco Ventana Coplanar	1,099
ADR 85440		Acople Módulo 54 mm	0,492
ADR 85436		Encuentro Doble Hoja Aper. Exterior	1,061
ADR 85435		Inversor de Marco	1,030
ADR 85430		Encuentro Doble Hoja Aper. Interior	1,146
ADR 85426		Travesaño Estrecho	1,143
ADR 85424		Travesaño Puerta Curvo	1,934
ADR 85423		Zócalo Puerta Curvo	1,897
ADR 85420		Travesaño	1,290
ADR 85415		Hoja Puerta Aper. Exterior Curva.	1,645
ADR 85414		Hoja Puerta Curva	1,519

Código	Diseño	Descripción	kg/m
ADR 85412		Hoja Balcón Curva	1,514
ADR 85411		Hoja Ventana Curva	1,248
ADR 85410		Hoja Ventana Curva Estrecha	1,077
ADR 85408		Marco Ventana Desplazable	1,058
ADR 85403		Marco Puerta	1,185
ADR 85402		Marco Ventana	1,038
ADR 85401		Marco Ventana Estrecho	0,903
ADR 2614		Tapajuntas curvo 34 mm atornillado	0,222
ADR 2104		Contra vidrio clip 25 mm Paño Fijo	0,277
ADR 2103		Contra vidrio recto 25 mm Paño Fijo	0,328
ADR 1861		Contra vidrio clip 18 mm	0,175

Código	Diseño	Descripción	kg/m
ADR 1860		Contravidrio clip 22 mm	0,187
ADR 1517		Tapajuntas Recto 25 mm atornillado	0,180
ADR 1489		Contravidrio recto 18 mm	0,299
ADR 1298		Tapajuntas recto 42 mm atornillado	0,312
ADR 1297		Tapajuntas recto 42 mm aplicar clip	0,243
ADR 1175		Contravidrio clip 16 mm	0,160
ADR 1174		Contravidrio curvo 16 mm	0,220
ADR 1163		Contravidrio recto 16 mm	0,228
ADR 921		Contravidrio clip 22 mm	0,179
ADR 920		Contravidrio curvo 22 mm	0,233
ADR 919		Contravidrio recto 22 mm	0,240

Código	Diseño	Descripción	kg/m
ADR 918		Contra vidrio clip 26 mm	0,192
ADR 917		Contra vidrio curvo 26 mm	0,248
ADR 916		Contra vidrio recto 26 mm	0,256
ADR 915		Contra vidrio clip 12 mm	0,147
ADR 914		Contra vidrio curvo 12 mm	0,209
ADR 913		Contra vidrio recto 12 mm	0,216
ADR 761	Premarco sin ala	0,372	
ADR 375		Premarco R700	0,605
ADR 255		Botaaguas	0,201
ADR 230		Premarco	0,463

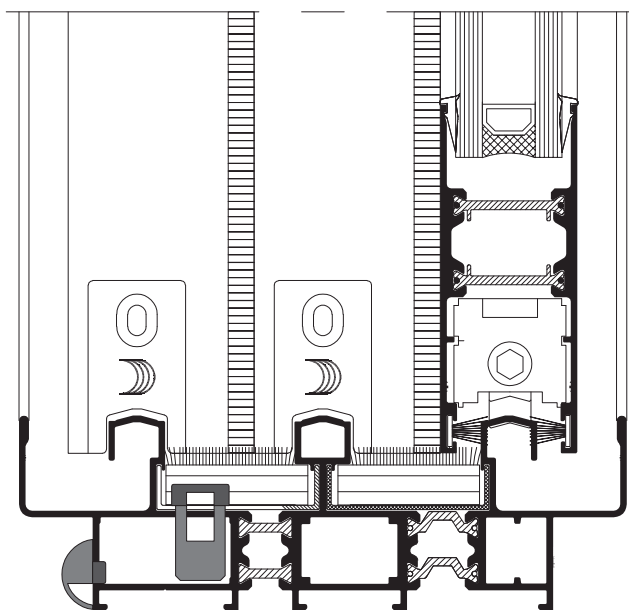

## TIPOLOGÍAS

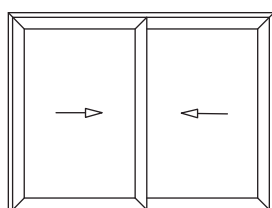

Corrediza 2 hojas

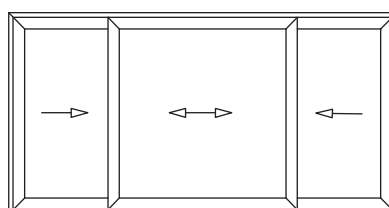

Corrediza 3 hojas en 2 guías

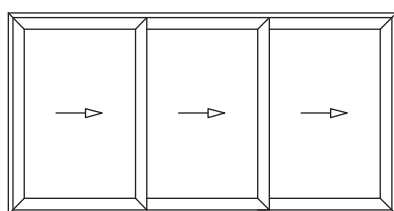



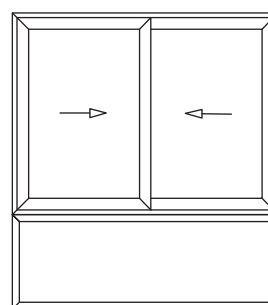







Corrediza 3 hojas en 3 guías









Corrediza + Paño Fijo

## HERREMENTAL NECESARIO

Código	Descripción
91005	Prensa base para sistema porta matrices Hydro Pack
91060	Matriz N1 HA62 RPT - Corrediza - Hydro Pack

Código	Diseño	Descripción	kg/m
ADR 86502		Marco corrediza 3 guías HA62 RPT	2,641
ADR 86501		Marco colector y guía mosq. HA62 RPT	1,659
ADR 86440		Acople RPT módulo 62 mm	0,587
ADR 85505		Hoja corrediza reforzada HA62 RPT Jxx = 54.4 cm <sup>4</sup>	1,870
ADR 85504		Hoja corrediza HA62 RPT Jxx = 7.4 cm <sup>4</sup>	1,207
ADR 3298		Cruce de hojas inercial Jxx = 35 cm <sup>4</sup>	1,095
ADR 2614		Tapajuntas curvo 34 mm atornillado	0,222
ADR 2462		Tapa premarco Doppia	0,191
ADR 1910		Tapa premarco R750	0,156
ADR 1909		Premarco R750	0,645
ADR 1880		Cruce de Hojas	0,341

Código	Diseño	Descripción	kg/m
ADR 1517		Tapajuntas Recto 25 mm atornillado	0,180
ADR 1298		Tapajuntas recto 42 mm atornillado	0,312
ADR 558		Mosquitero reforzado	0,634
ADR 375		Premarco R700	0,605
ADR 230		Premarco	0,463
ADR 12		Mosquitero	0,277
ADR 11		Travesaño mosquitero	0,473



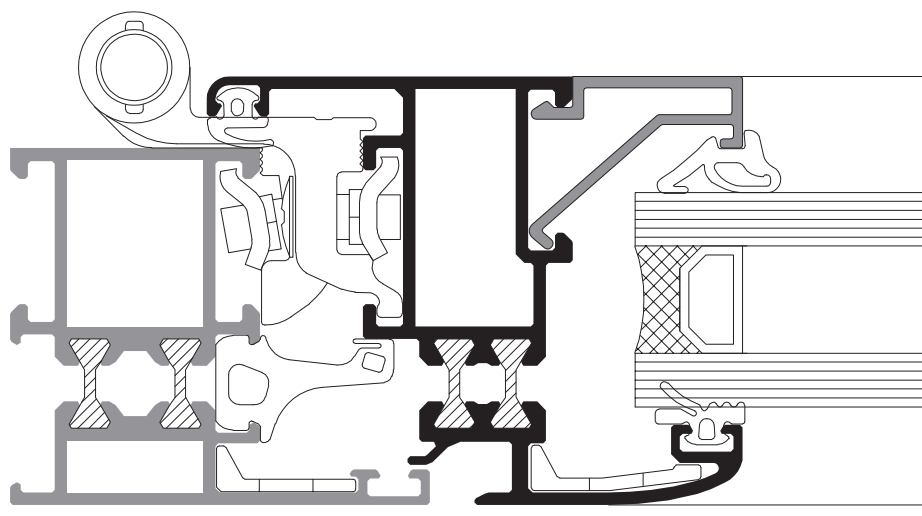

## TIPOLOGÍAS

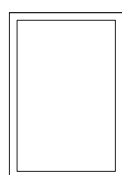

Paño Fijo

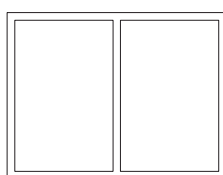

Paño Fijo Compuesto

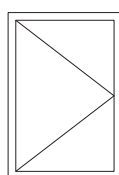

Ventana 1 hoja  
Batiente / Oscilobatiente

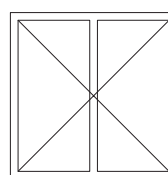

Ventana 2 hojas  
Batiente / Oscilobatiente

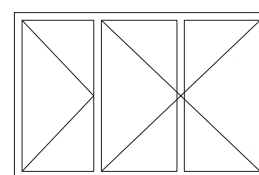

Ventana 3 hojas  
Batiente / Oscilobatiente

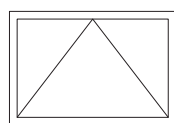

Banderola

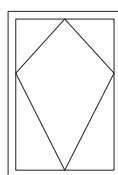

Desplazable

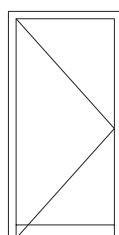



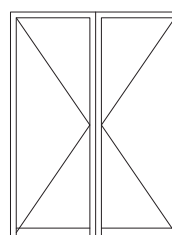



Puerta 1 hoja  
Apertura Interior





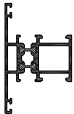
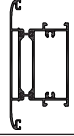
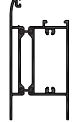

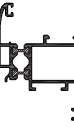
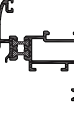









Puerta 2 hojas  
Apertura Interior

## HERREMENTAL NECESARIO

Código	Descripción
91005	Prensa base para sistema porta matrices Hydro Pack
91061	Matriz N1 HA62 RPT - Corrediza - Hydro Pack

Código	Diseño	Descripción	kg/m
ADR 85441		Acople RPT 40/54 mm	0,472
ADR 85040		Acople RPT 40/40 mm	0,443
ADR 85030		Encuentro doble hoja aper. interior	1,048
ADR 85026		Travesaño estrecho	1,045
ADR 85024		Travesaño puerta curvo	1,895
ADR 85023		Zócalo puerta curvo	1,801
ADR 85020		Travesaño	1,192
ADR 85012		Hoja balcón curva	1,400
ADR 85011		Hoja ventana curva	1,134
ADR 85010		Hoja ventana curva estrecha	0,963
ADR 85008		Marco ventana desplazable	0,960

Código	Diseño	Descripción	kg/m
ADR 85003		Marco puerta	1,087
ADR 85002		Marco ventana	0,940
ADR 85001		Marco ventana estrecho	0,805
ADR 2614		Tapajuntas curvo 34 mm atornillado	0,222
ADR 1517		Tapajuntas recto 25 mm atornillado	0,180
ADR 1298		Tapajuntas recto 42 mm atornillado	0,312
ADR 1297		Tapajuntas recto 42 mm aplicar clip	0,243
ADR 915		Contra vidrio clip 12 mm	0,147
ADR 914		Contra vidrio curvo 12 mm	0,209
ADR 913		Contra vidrio recto 12 mm	0,216
ADR 912		Contra vidrio clip 8 mm	0,134

<b>Código</b>	<b>Diseño</b>	<b>Descripción</b>	<b>kg/m</b>
ADR 911		Contra vidrio curvo 8 mm	0,203
ADR 910		Contra vidrio recto 8 mm	0,211
ADR 761		Premarco sin ala	0,372
ADR 255		Botaaguas	0,201

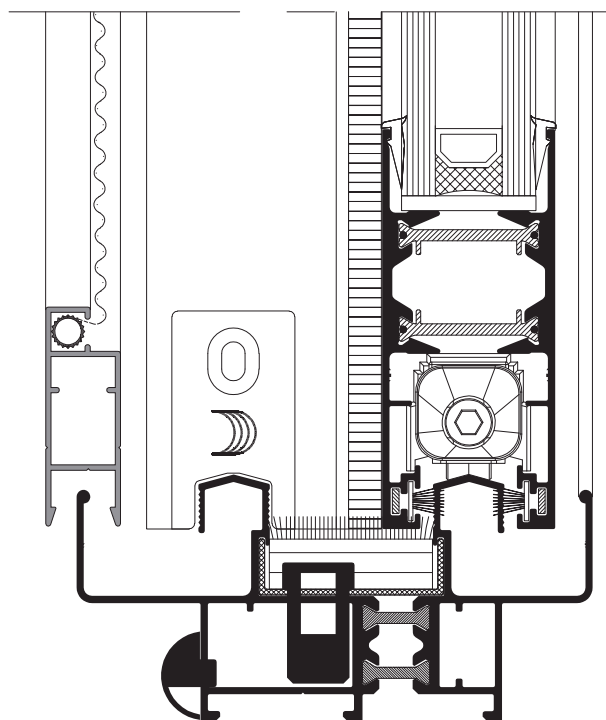

## TIPOLOGÍAS

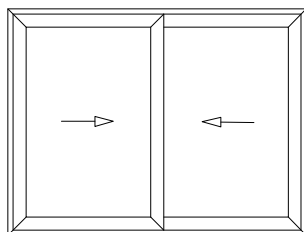

Corrediza 2 hojas

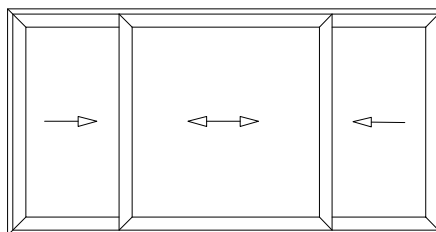



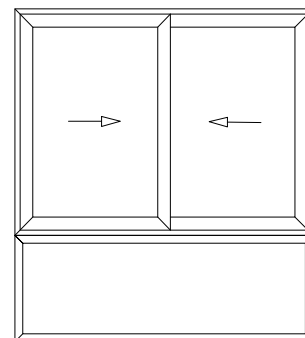





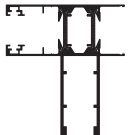

Corrediza 3 hojas en 2 guías

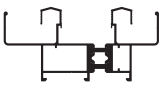



Corrediza + Paño Fijo

## HERREMENTAL NECESARIO

Código	Descripción
91005	Prensa base para sistema porta matrices Hydro Pack
91060	Matriz N°1 HA62 RPT - Corrediza - HydroPack

Código	Diseño	Descripción	kg/m
ADR 85452		Hoja corrediza reforzada R640 RPT Jxx = 56 cm <sup>4</sup>	1,889
ADR 85451		Hoja corrediza R640 RPT Jxx = 7 cm <sup>4</sup>	1,060
ADR 85450		Marco colector y guía mosquitero R640 RPT	1,362
ADR 85441		Acople RPT módulo 40/54 mm.	0,472
ADR 85440		Acople RPT módulo 54 mm.	0,492
ADR 3696		Cruce de hojas R640 RPT	0,283
ADR 2614		Tapajuntas curvo 34 mm. atornillado	0,222
ADR 1517		Tapajuntas recto 25 mm. atornillado	0,180
ADR 1298		Tapajuntas recto 42 mm. atornillado	0,312
ADR 558		Mosquitero reforzado	0,634
ADR 230		Premarco	0,463



Código	Diseño	Descripción	kg/m
ADR 12		Mosquitero	0,277
ADR 11		Travesaño mosquitero	0,473



# ALUMAK

SOLUCION EN ALUMINIO

Av. Zeballos 1879/87/99  
(CP1708) Morón, Prov. de Bs. As., Argentina  
Tel: 5411 4483-2471 | 4629-8001 | 0507

Seguinos en las redes!!



alumakperfilesaluminio



@alumaksa



alumakperfilesaluminio

[www.alumaksa.com.ar](http://www.alumaksa.com.ar)



Hydro